

Legenda dos Níveis

- Pav. que mais
- Pav. que menos
- Pav. que mais
- Pav. que menos

Legenda dos Tipos

- Vigas contínuas
- Vigas e arcos contínuas

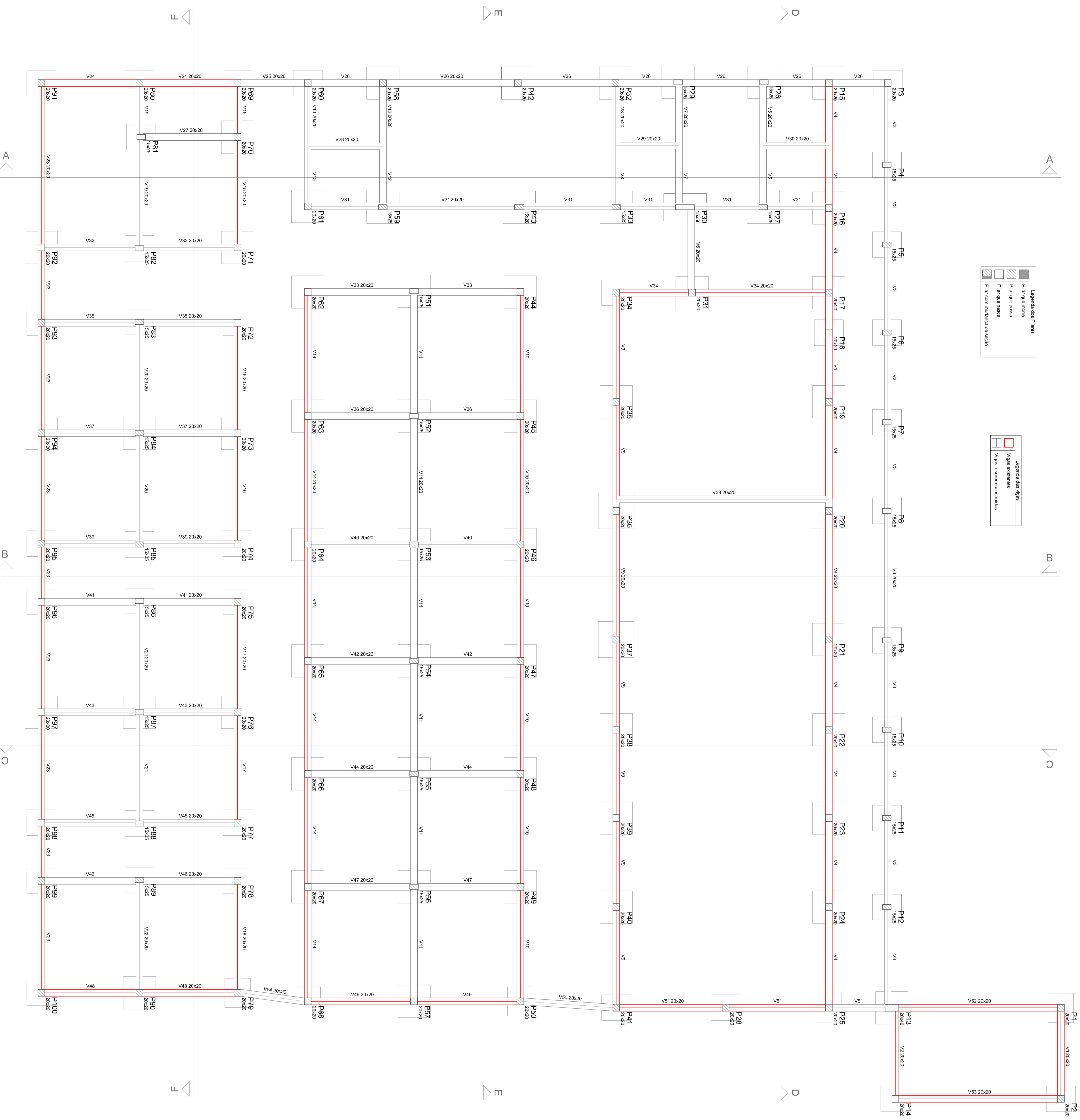

Verificação dos momentos

Viga	Seção	Emprego	M _{max} (kNm)	M _{min} (kNm)
V1	20x20	0	0	0
V2	20x20	0	0	0
V3	20x20	0	0	0
V4	20x20	0	0	0
V5	20x20	0	0	0
V6	20x20	0	0	0
V7	20x20	0	0	0
V8	20x20	0	0	0
V9	20x20	0	0	0
V10	20x20	0	0	0
V11	20x20	0	0	0
V12	20x20	0	0	0
V13	20x20	0	0	0
V14	20x20	0	0	0

Verificação dos momentos

Viga	Seção	Emprego	M _{max} (kNm)	M _{min} (kNm)
P1	20x20	0	0	0
P2	20x20	0	0	0
P3	20x20	0	0	0
P4	20x20	0	0	0
P5	20x20	0	0	0
P6	20x20	0	0	0
P7	20x20	0	0	0
P8	20x20	0	0	0
P9	20x20	0	0	0
P10	20x20	0	0	0
P11	20x20	0	0	0
P12	20x20	0	0	0
P13	20x20	0	0	0
P14	20x20	0	0	0
P15	20x20	0	0	0
P16	20x20	0	0	0
P17	20x20	0	0	0
P18	20x20	0	0	0
P19	20x20	0	0	0
P20	20x20	0	0	0
P21	20x20	0	0	0
P22	20x20	0	0	0
P23	20x20	0	0	0
P24	20x20	0	0	0
P25	20x20	0	0	0
P26	20x20	0	0	0
P27	20x20	0	0	0
P28	20x20	0	0	0

1 PLANTA DE FORMA DO PAVIMENTO TERREO

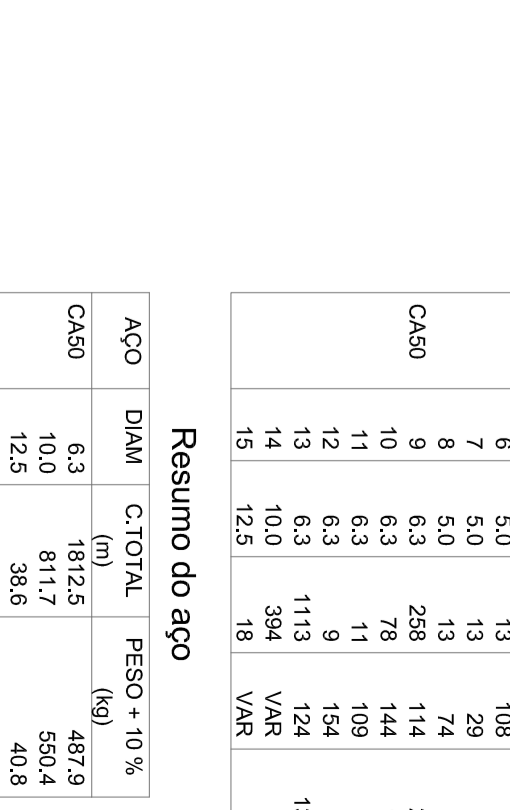
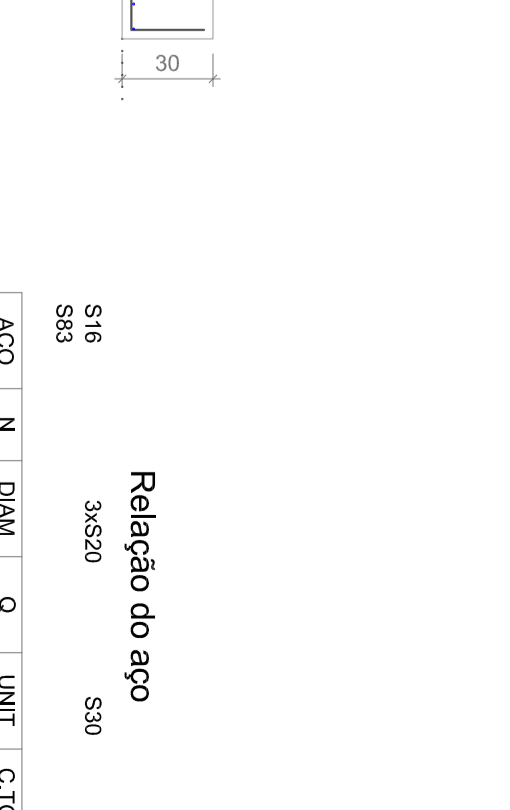
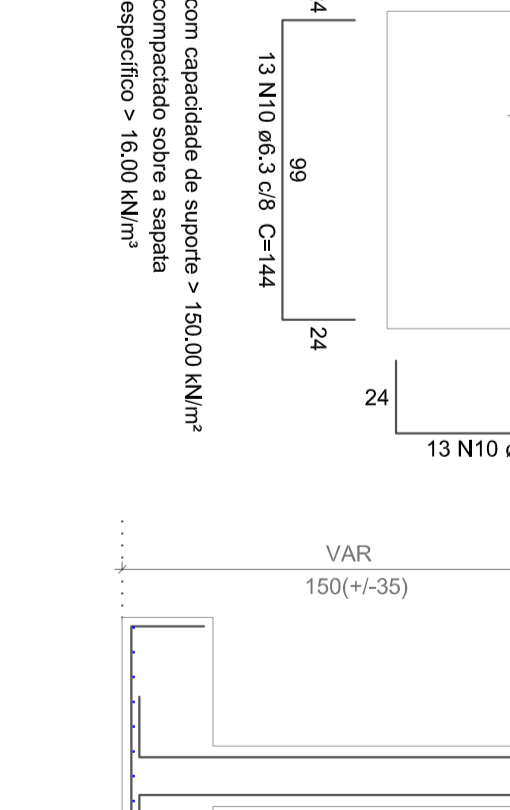
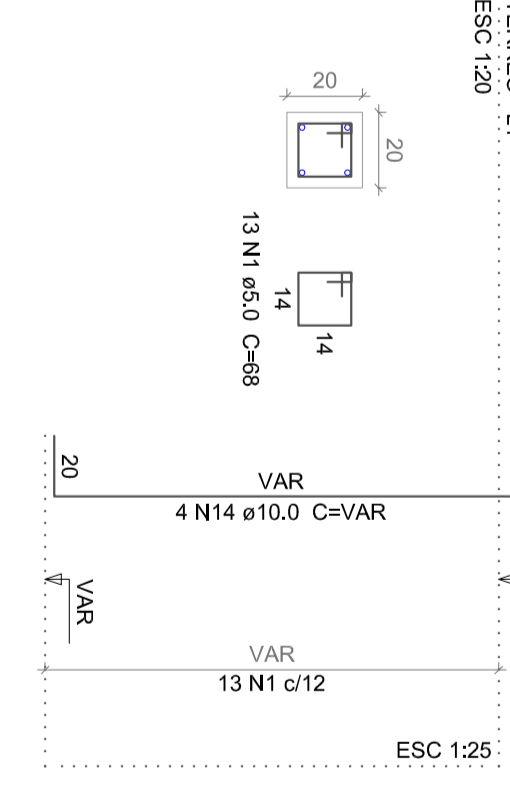
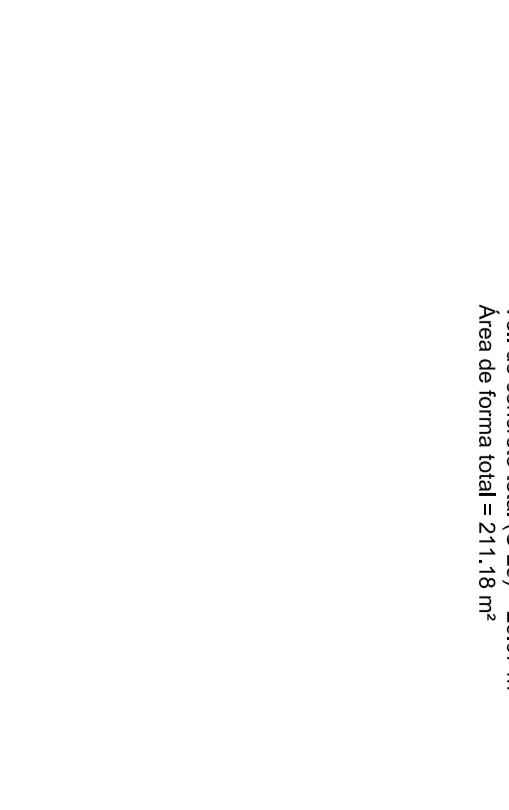
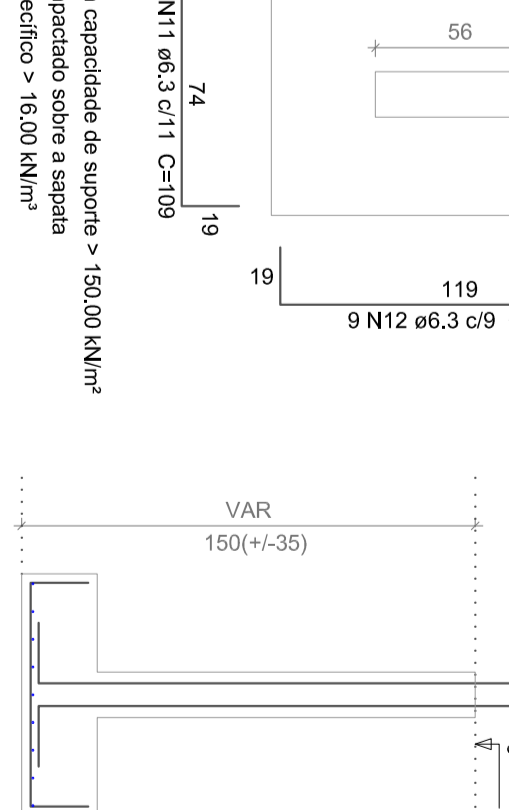
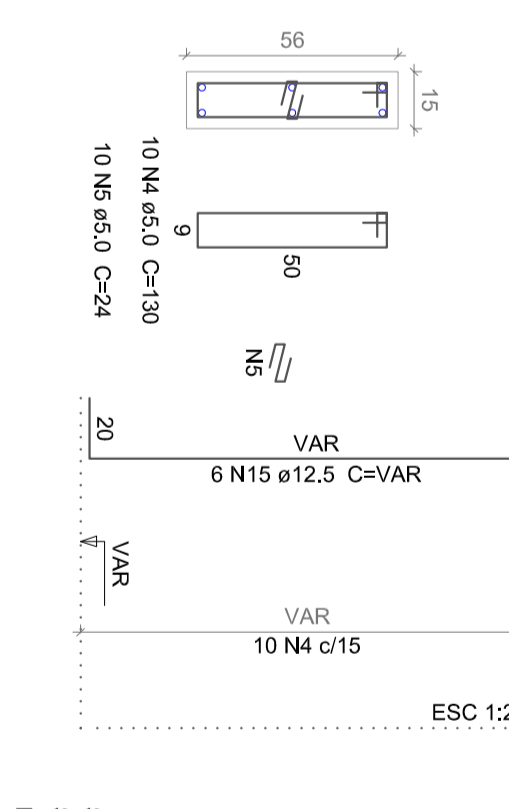
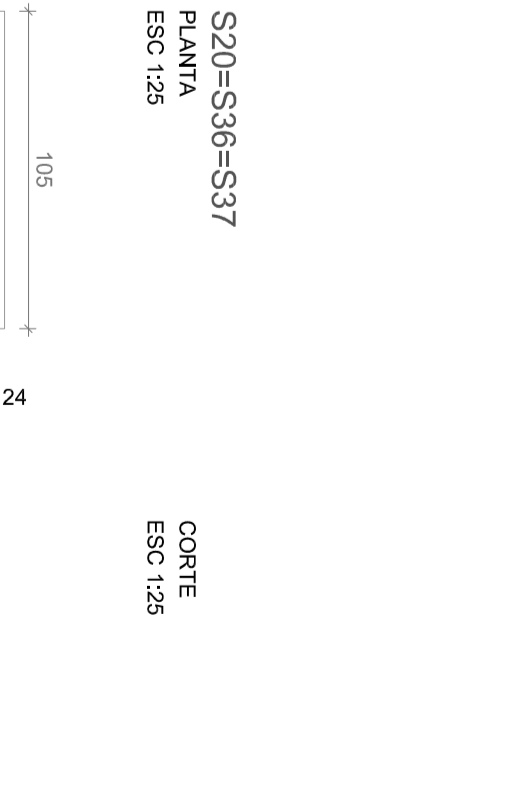
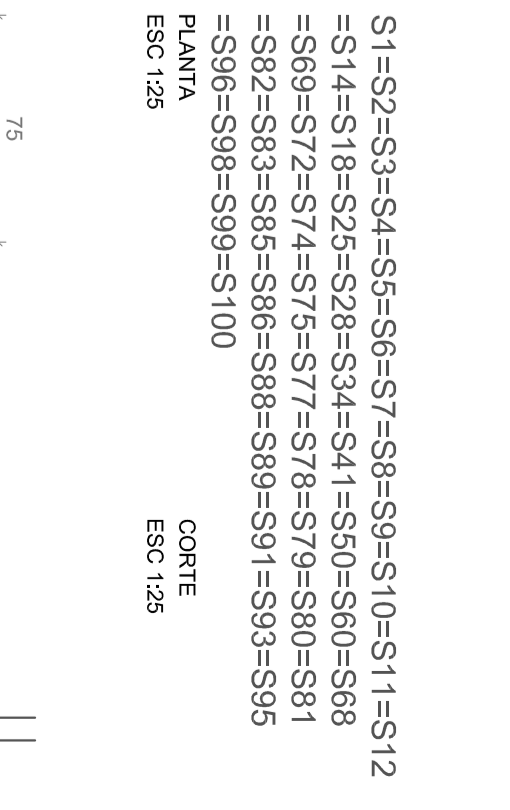
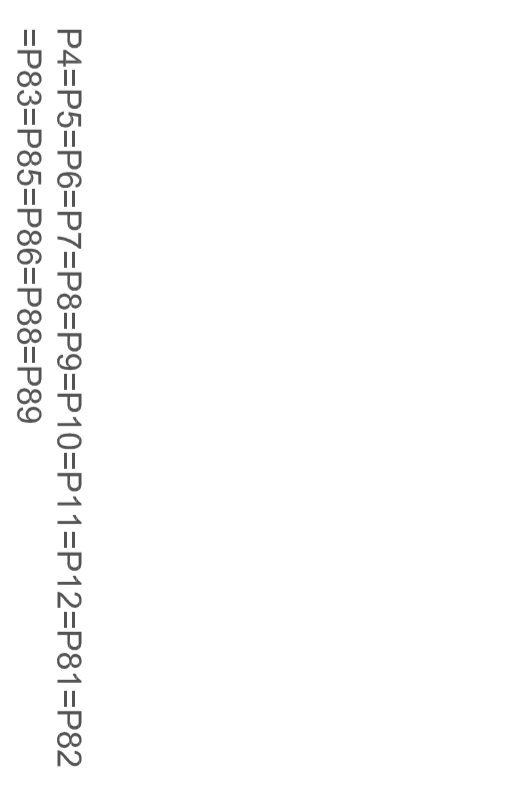
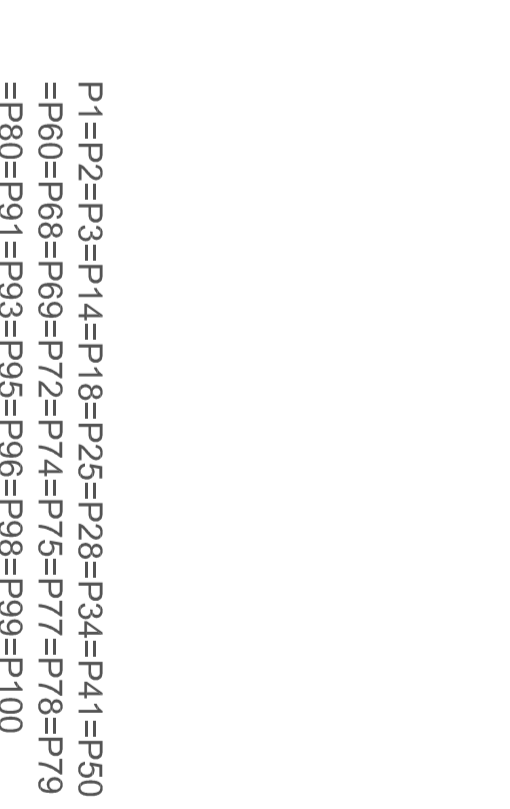
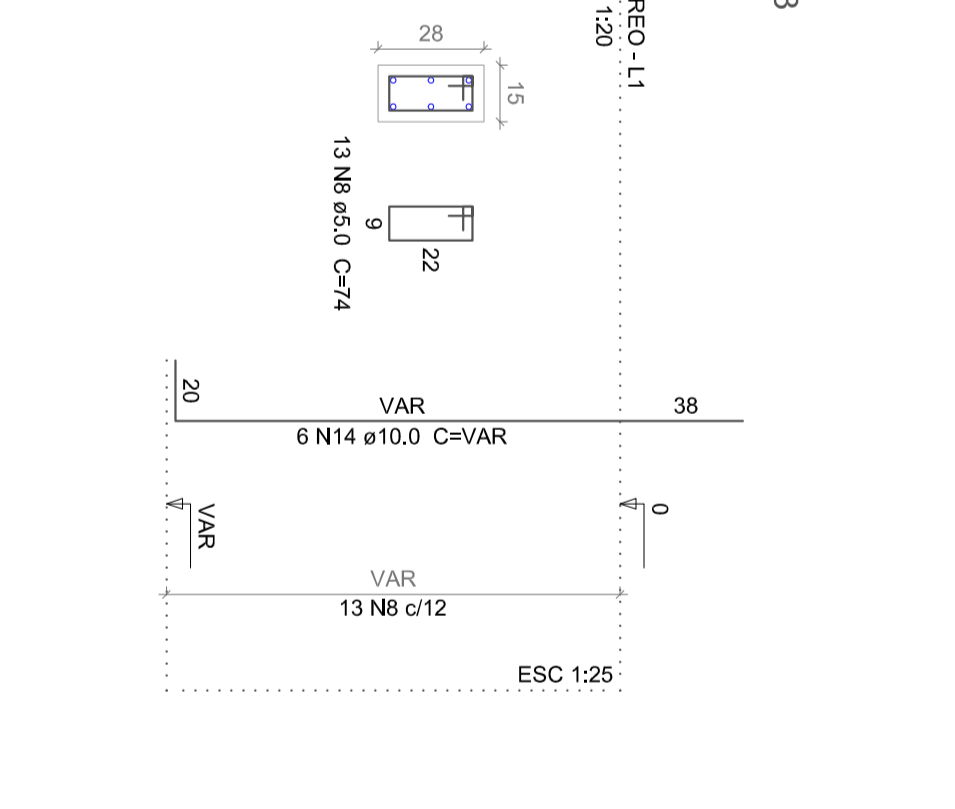
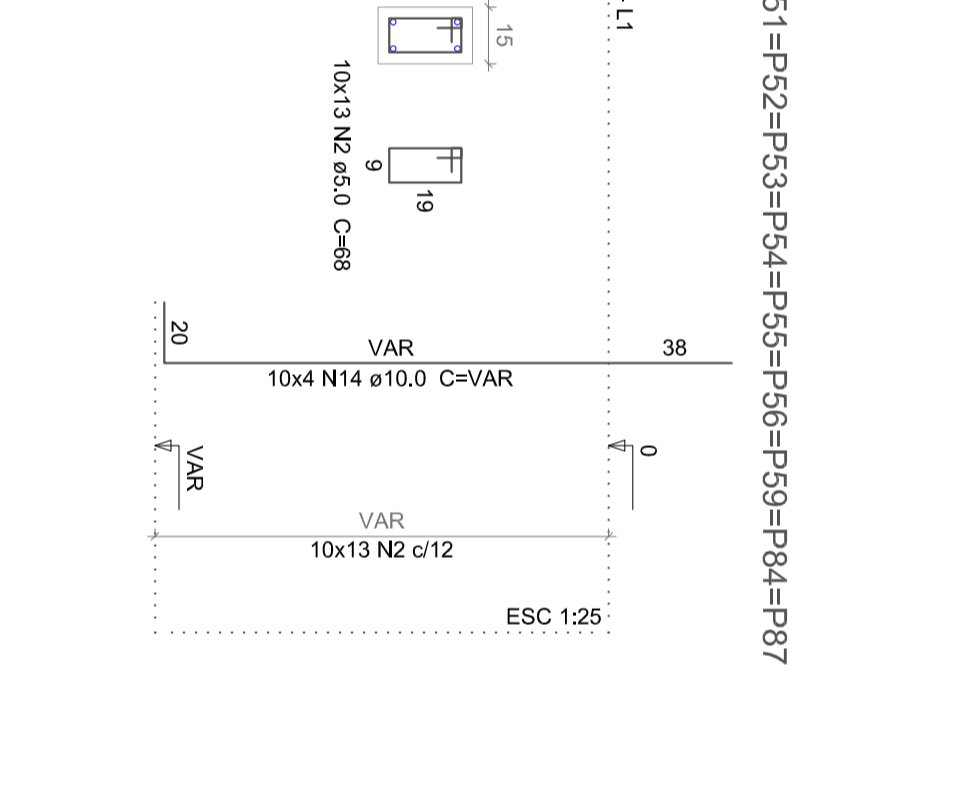
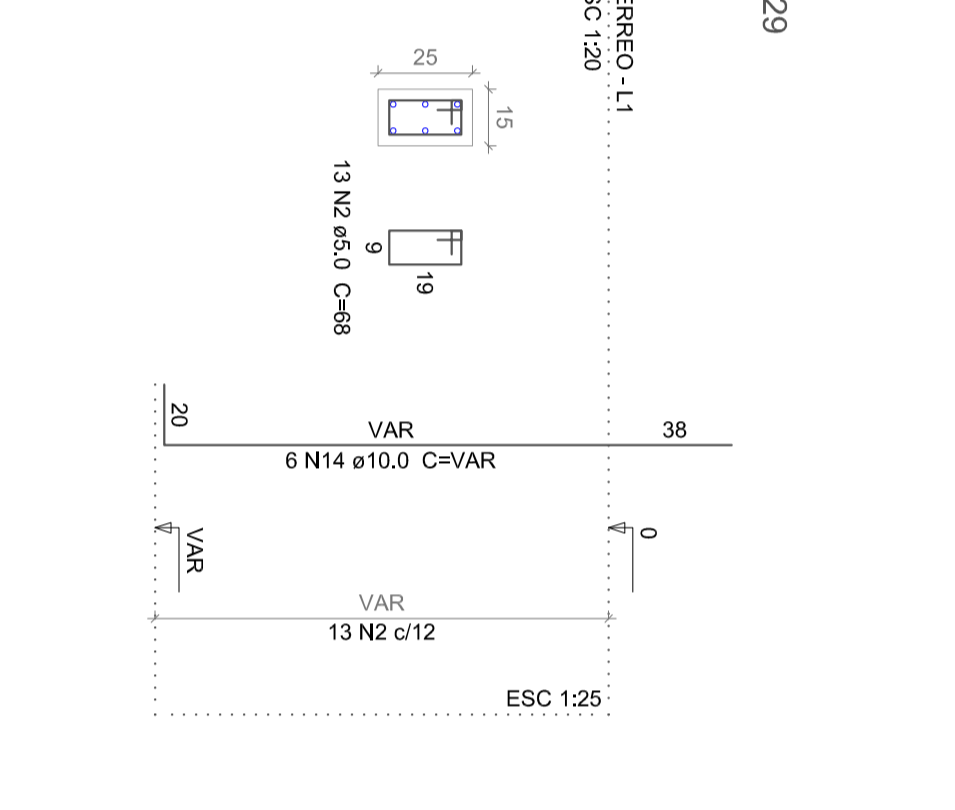
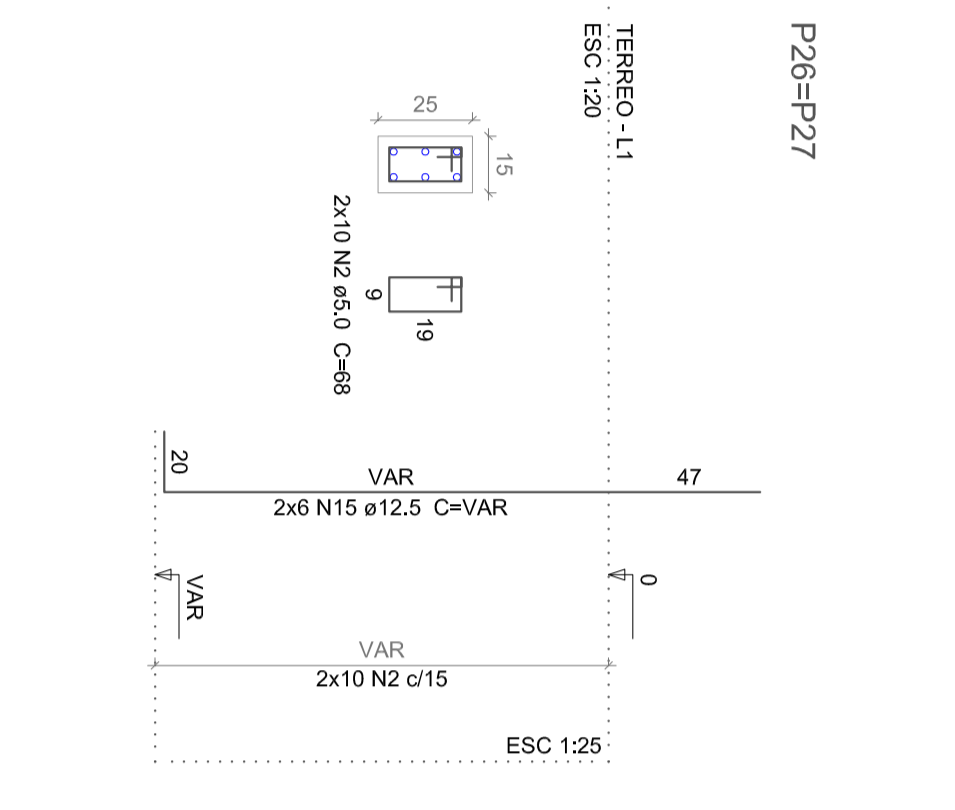
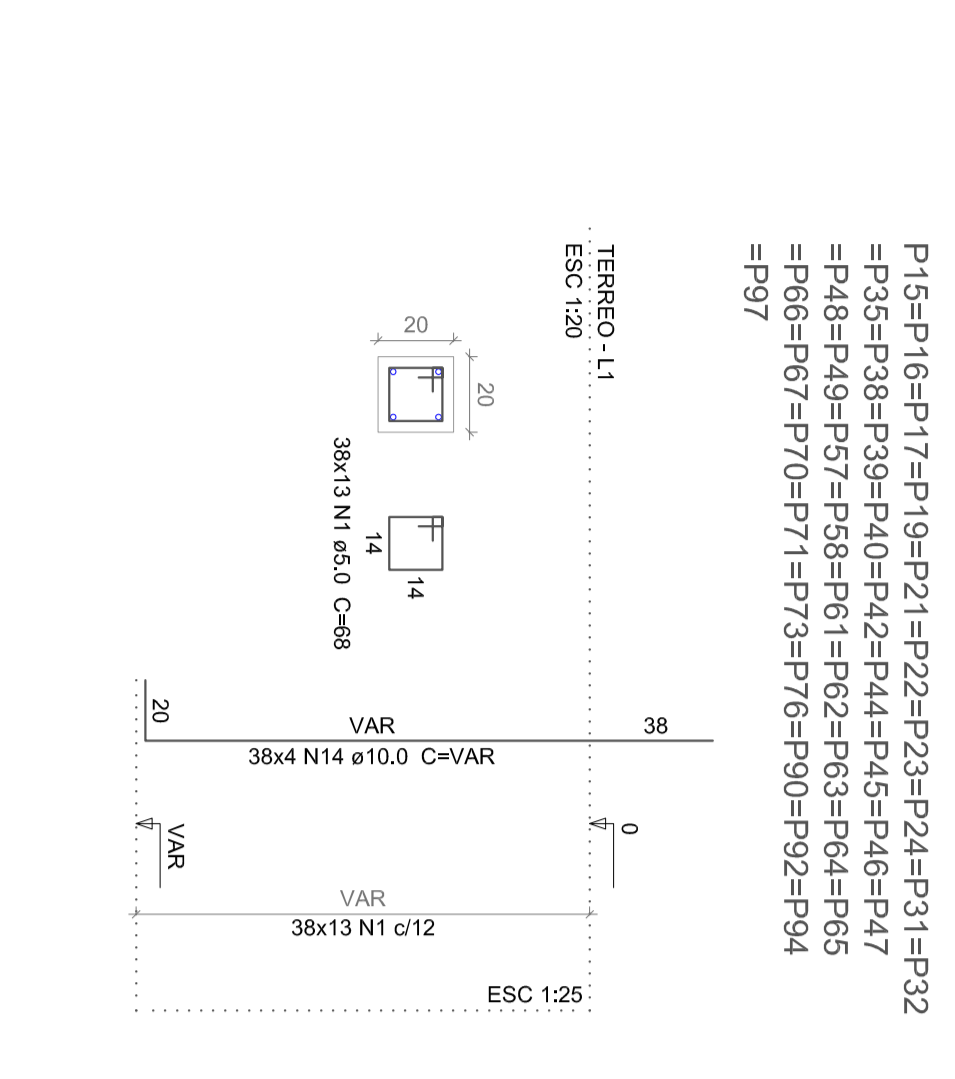
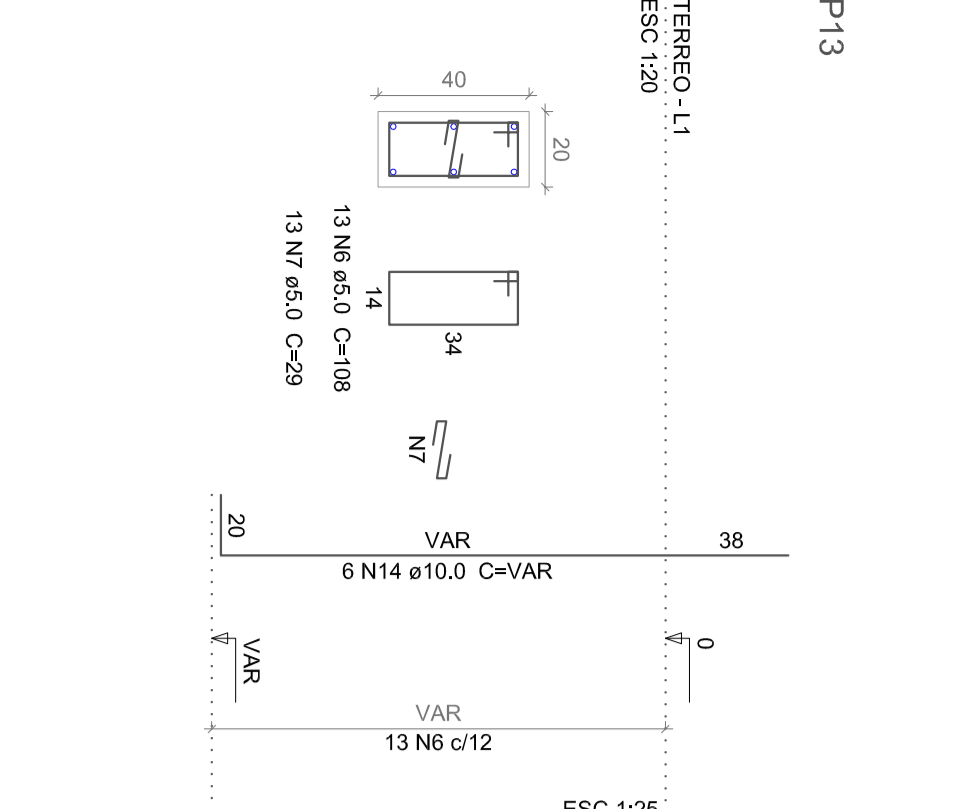

Resumo do aço

ACO	N	DIM	UNIT	C.OTM	FE50 - 0.9 %
C60	2	6.0	371	88	22228
C60	4	5.0	130	1300	6500
C60	6	5.0	10	24	1440
C60	7	5.0	13	29	377
C60	9	5.0	258	14	1142
C60	10	5.0	79	144	11132
C60	12	5.0	138	14	1398
C60	14	5.0	38	19	1908
C60	15	5.0	38	19	1908

